



Hot Water Generation – Steam/Water Single Wall

Flo-Rite-Temp® Steam/Water Shell and Tube Heat Exchanger Pre-Piped Single Temperature

Model FRT665

Flo-Rite-Temp instantaneous water heater assembly for non-recirculating hot water systems. Flo-Rite-Temp pre-piped single temperature systems offer three heat exchanger options fully assembled and include: steam trap, air vent, thermometer, Clean-In-Place connection ports, vacuum breaker, and isolation valves.

Operational Specifications

- +/-4°F water temperature control at points of use 25' downstream during demand
- Feed-forward control utilizing pressure sensitive fail safe (cold) control valve
- Straight admiralty brass tube bundle with removable floating end cover for mechanical cleaning
- Utilizes constant low pressure steam to assure positive condensate drainage of exchanger
- Only 4 connections required: steam, condensate, cold water, mixed water out

Technical Specifications

- Maximum steam pressure: 15 PSIG
- Maximum domestic pressure: 150 PSI
- Maximum designed water side pressure drop: 10 PSI
- Design conditions: Domestic-63 GPM at 100°F delta T using 15 PSIG steam
- Complete assembly Lead Free Compliant
- All domestic side valve fittings and isolation valves, strainers, inlet check valves, inlet and system blend thermometers pre-piped.
- Clean-In-Place connections for chemically cleaning of control valve and heat exchanger without disassembly of the Flo-Rite-Temp
- Heat exchanger tubes shall be straight 5/8" OD admiralty brass expanded into Navel Brass tube sheets with a free floating bolted end cover
- Water pipe of type L copper
- Fabricated carbon steel frame with machine grade enamel paint

Standard Materials of Construction

- Control Valve: Lead Free Bronze
- Water pipe: Type L Copper
- Fittings: Lead Free Brass/Bronze
- Tube bundle: Admiralty Brass tubes expanded into Navel Brass tube sheets
- Heat Exchanger Shell: Carbon Steel
- Steam Trap: Model 814 Cast Iron
- Air Vent: Model TS-2 angle-pattern-bronze
- Vacuum Breaker: Brass

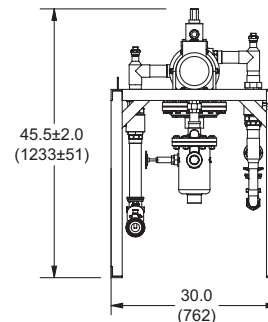
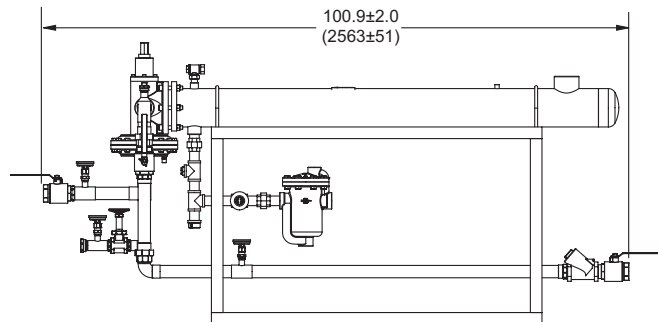
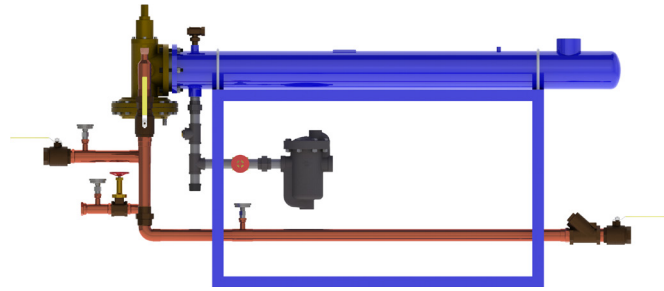

Designs, materials, weights and performance ratings are approximate and subject to change without notice. Visit armstronginternational.com for up-to-date information.