



Hot Water Generation – Steam/Water Double Wall

Flo-Rite-Temp® Steam/Water Shell and Tube Heat Exchanger Pre-Piped Recirculating Single Temperature

Model FRT535DWR

Flo-Rite-Temp instantaneous water heater assembly for recirculating hot water systems. Flo-Rite-Temp pre-piped single temperature systems offer three heat exchanger options fully assembled and include: steam trap, air vent, thermometer, Clean-In-Place connection ports, vacuum breaker, diverting valve, and isolation valves.

Operational Specifications

- +/-4°F water temperature control at points of use 25' downstream during demand
- Feed-forward control utilizing pressure sensitive fail safe (cold) control valve
- Utilizes constant low pressure steam to assure positive condensate drainage of exchanger
- Only 5 connections required: steam, condensate, cold water, recirculation return, and mixed water out
- Double wall u-band tube bundle with vent to atmosphere between tube sheets to indicate tube failure

Technical Specifications

- Maximum steam pressure: 15 PSIG
- Maximum domestic pressure: 150 PSI
- Maximum designed water side pressure drop: 10 PSI
- Design conditions: Domestic-35 GPM at 100°F delta T using 15 PSIG steam
- Complete assembly Lead Free Compliant
- All domestic side valve fittings and isolation valves, strainers, thermostatic diverting valve, inlet check valves, inlet and system blend thermometers pre-piped.
- Clean-In-Place connections for chemically cleaning of control valve and heat exchanger without disassembly of the Flo-Rite-Temp
- Heat exchanger tubes shall be double wall wall 5/8" copper inner tube and 3/4" grooved copper outer tube expanded into brass/stainless steel tube sheet with indicating weep holes
- Water pipe of type L copper
- Fabricated carbon steel frame with machine grade enamel paint

Standard Materials of Construction

- Control Valve: Lead Free Bronze
- Water pipe: Type L Copper
- Fittings: Lead Free Brass/Bronze
- Tube bundle: Double wall copper with Navel Brass and stainless steel tube sheets
- Heat Exchanger Shell: Carbon Steel
- Steam Trap: Model 813 Cast Iron
- Air Vent: Model TS-2 angle-pattern-bronze
- Vacuum Breaker: Brass
- Thermostatic Diverting Valve: Lead Free Bronze

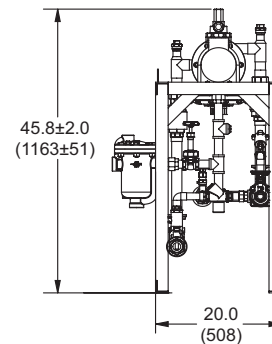
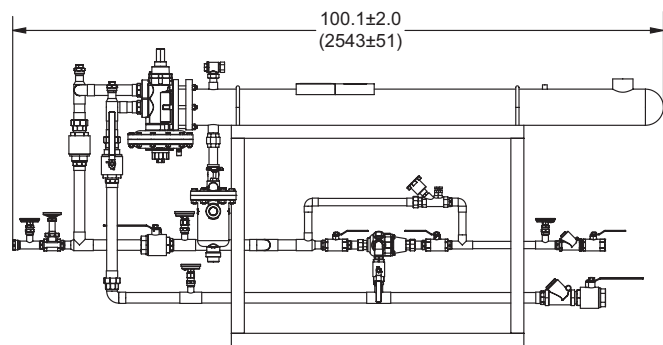
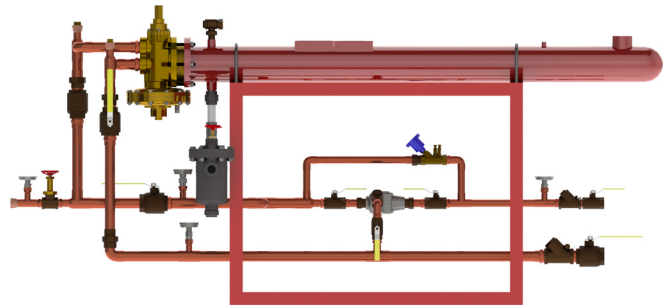

Designs, materials, weights and performance ratings are approximate and subject to change without notice. Visit armstronginternational.com for up-to-date information.